

National Institute of Neurological Disorders and Stroke  
Biorepository:

**BioSpecimen Exchange for Neurological Disorders, BioSEND**

**Biospecimen Collection, Processing, and Shipment Manual for  
Lewy Body Dementia (LBD) Emory (PDBP Study ID 238)**

## Table of Contents

<b>1.0</b>	<b><a href="#">Purpose</a></b> .....	<b>4</b>
<b>2.0</b>	<b><a href="#">Abbreviations</a></b> .....	<b>4</b>
<b>3.0</b>	<b><a href="#">BioSEND Information</a></b> .....	<b>5</b>
3.1	<a href="#">BioSEND Contacts</a>	
3.2	<a href="#">Hours of Operation</a>	
3.3	<a href="#">Holiday Schedules</a>	
3.4	<a href="#">Holiday Observations</a>	
<b>4.0</b>	<b><a href="#">BioSEND Sample Requirements</a></b> .....	<b>7</b>
4.1	<a href="#">Protocol Schedule for Biospecimen Submission</a>	
<b>5.0</b>	<b><a href="#">Specimen Collection Kits, Shipping and Supplies</a></b> .....	<b>9</b>
5.1	<a href="#">Kit Supply to Study Sites</a>	
5.2	<a href="#">Specimen Collection Kit General Contents</a>	
5.3	<a href="#">Specimen Collection Kit Contents</a>	
5.4	<a href="#">Site Required Equipment</a>	
<b>6.0</b>	<b><a href="#">Specimen Labels</a></b> .....	<b>14</b>
6.1	<a href="#">Types of Labels</a>	
6.2	<a href="#">Affixing Labels</a>	
<b>7.0</b>	<b><a href="#">Specimen Collection and Processing Procedures</a></b> .....	<b>16</b>
7.1	<a href="#">Order of Specimen Collection</a>	
7.2	<a href="#">Blood Collection Protocols</a>	
7.3	<a href="#">Lumbar Puncture Protocol</a>	
7.4	<a href="#">Filling Aliquot Tubes</a>	
<b>8.0</b>	<b><a href="#">Packaging and Shipping Instructions</a></b> .....	<b>18</b>
8.1	<a href="#">Sample Collection and Processing Form</a>	
8.2	<a href="#">Shipping Instructions</a>	
8.3	<a href="#">Shipping Address</a>	
<b>9.0</b>	<b><a href="#">Data Queries and Reconciliation</a></b> .....	<b>20</b>

**10.0** [Appendices](#) .....**21**

- Appendix A: Whole Blood Collection for Isolation of RNA
- Appendix B: Whole Blood Collection for Isolation of Plasma
- Appendix C: Whole Blood Collection for Isolation of Buffy Coat
- Appendix D: Whole Blood Collection for Banking
- Appendix F: Whole Blood Collection for Isolation of Serum
- Appendix G: Cerebrospinal Fluid Collection
- Appendix I: Sample Collection and Processing Form
- Appendix K: Frozen Shipping Instructions
- Appendix O: Low Fat Diet Menu Suggestions
- Appendix Q: UPS ShipExec™ Thin Client Instructions

## 1.0 PURPOSE

The purpose of this manual is to provide collection site staff (PIs, study coordinators, and the sample collection and processing teams) at various study sites with instructions for collection and submission of biological samples. It includes instructions for biospecimen submission to the BioSpecimen Exchange for Neurological Disorders (BioSEND) located at Indiana University.

This manual includes instructions for the collection, processing, aliquoting and shipping of the following samples:

- Serum
- PAXgene® (for RNA extraction)
- Plasma
- Buffy Coat (for DNA extraction)
- Whole Blood (for banking)
- CSF

These procedures are relevant to all study personnel responsible for processing blood specimens to be submitted to BioSEND.

## 2.0 ABBREVIATIONS

BioSEND	BioSpecimen Exchange for Neurological Disorders
CSF	Cerebrospinal Fluid
EDTA	Ethylene Diamine Tetra-acetic Acid
IATA	International Air Transport Association
PDBP	Parkinson's Disease Biomarkers Program
RBC	Red Blood Cells
RCF	Relative Centrifugal Force
RPM	Revolutions Per Minute
LBD	Lewy Body Dementia

### 3.0 BioSEND INFORMATION

#### 3.1 BioSEND Contacts

**Tatiana Foroud, PhD, Principal Investigator**

**Claire Wegel, Project Manager**

Email: [cwegel@iu.edu](mailto:cwegel@iu.edu)

#### **General BioSEND Contact Information**

Phone: [317-278-0594](tel:317-278-0594)

Email: [biosend@iu.edu](mailto:biosend@iu.edu)

Website: [www.BioSEND.org](http://www.BioSEND.org)

#### **Sample Shipment Mailing Address**

BioSEND

Indiana University School of Medicine

351 W. 10<sup>th</sup> Street. TK-217

Indianapolis, IN 46202-5188

#### 3.2 Hours of Operation

Indiana University business hours are from 8 AM to 5 PM Eastern Time, Monday through Friday.

**Frozen samples must be shipped Monday- Wednesday only.**

For packaging and shipment details, please refer to Appendix K (Frozen Shipping Instructions) and Appendix Q (UPS ShipExec™ Thin Client Instructions).

Check the weather reports and the shipping courier website to make sure impending weather events (blizzards, hurricanes, etc.) will not impact the shipping or delivery of the samples. Couriers often report anticipated weather delays on their website.

### 3.3 Holiday Schedules

- Please note that courier services may observe a different set of holidays. Please be sure to verify shipping dates with your courier prior to any holiday.
- **Weekend/holiday deliveries will not be accepted.**

### 3.4 Holiday Observations

Date	Holiday
January 1	New Year’s Day
3 <sup>rd</sup> Monday in January	Martin Luther King, Jr Day
4 <sup>th</sup> Monday in May	Memorial Day
June 19	Juneteenth (observed)
July 4	Independence Day (observed)
1 <sup>st</sup> Monday in September	Labor Day
4 <sup>th</sup> Thursday in November	Thanksgiving
4 <sup>th</sup> Friday in November	Friday after Thanksgiving
December 25	Christmas Day

Please note that BioSEND has extended closures to inbound shipments around the Thanksgiving and Christmas holidays. In addition to sending advance notification of these closures to sites, dates will be posted on the BioSEND website. Frozen specimens collected during this period should be held at your site to ship after the first business day in January. If you are ever unsure whether or not it is safe to ship samples, please email [biosend@iu.edu](mailto:biosend@iu.edu) to confirm.

#### 4.0 BIOSEND SAMPLE REQUIREMENTS

NINDS approves each study for a specific biospecimen collection protocol. Studies and study sites should make every effort to meet their approved biospecimen collection requirements. The expected number of samples from each site that should be returned to BioSEND are listed in [sections 4.1-4.2](#).

If a sample is not obtained at a particular visit, this should be recorded in the notes section of the **Sample Collection and Processing Form (see Appendix I)**. This form is submitted with your sample shipment to BioSEND.

**4.1 Protocol Schedule for Biospecimen Submission to BioSEND - LBD Emory**

Visit (month)	BL	12	24	36	48
Serum aliquots, 1ml	6	6	6	6	6
Whole blood for RNA (PAXGene® tube, 2.5ml)	2	2	2	2	2
Plasma aliquots, 1ml	6	6	6	6	6
Buffy Coat	2	2	2	2	2
Whole blood for banking, 3ml	1	1	1	1	1
CSF aliquots, 1ml	10		10		10



## 5.0 SPECIMEN COLLECTION KITS, SHIPPING KITS AND SUPPLIES

Research specimen collection kits will be provided by BioSEND. BioSEND will provide a sufficient number of labels and supplies only for those specimens that are to be shipped back to the BioSEND repository (See the Protocol Schedule for Biospecimen Submission to BioSEND for your site in [Sections 4.1-4.2](#)); any tubes that will remain at the collection site should be labeled accordingly. Ensure that all tubes are properly labeled according to [Section 6.2](#).

### 5.1 Kit Supply to Study Sites

Within the kit request module, there is a drop down menu to request kits based on the Principal Investigator at that site. Kits and individual items can be ordered as required through the kit request module.

The link to the kit request module is shown below:

- LBD: <http://kits.iu.edu/biosend/EmoryLBD>

Please allow **TWO weeks** for kit orders to be processed and delivered.

## 5.2 Specimen Collection Kit General Contents

Collection kits contain the following (for each subject) as designated per your protocol and/or NINDS resource development agreement. Kits provide the necessary supplies to collect samples from a given subject. Do not replace or supplement any of the tubes or kit components provided with your own supplies unless you have received approval from the NINDS/BioSEND Study team to do so. Please store all kits at room temperature until use.

### BioSEND Supplies

Available upon request from the online kit request module ([Section 5.1](#))

<b>General Items</b>
25 cell cryobox
Cryovial tube (2 ml) with clear cap
Airway bill envelope
Shipping container for dry ice shipment (shipping and Styrofoam® box)
Plastic biohazard bag
Warning label packet
<b>CSF Items</b>
Needle - Spinal Needle Introducer 20G, 0.90 x 32mm
Needle - Whitacre Needle 24G, 0.55 x 90mm
2 Individually Packaged Sterile 50 ml Conical Tube
Conical centrifuge tubes (15 ml)
Lumbar puncture tray (Sprotte® 24G or 22G) (see Lumbar Puncture Tray Components)
<b>Blood Collection Items</b>
PAXgene® tube (2.5 ml)
Lavender-top EDTA blood collection tube (10 ml)
Purple-top EDTA blood collection tube (3 ml)
Serum (red top) blood collection tube (10 ml)
O 15mL conical tubes for separation of Plasma from Buffy Coat

We realize there may be instances where additional supplies are needed; therefore, one supplemental kit will be provided with the initial kit shipment for new studies. Replacement supplemental kits can be requested on the kit request website. In addition, individual supplies can be requested as well.

Quantity	Lumbar Puncture Tray Components
1	Sprotte® needle, 24G x 90mm <u>OR</u> Sprotte® needle, 22G x 90mm
1	Introducer needle, 1 mm x 30 mm
1	Hypodermic needle, 22G x 1.5"
1	Plastic syringe, (3 ml, luer lock) with 25G x 5/8" needle attached
4	Polypropylene syringe (6 ml, luer lock)
1	Needle stick pad
1	Adhesive bandage
1	Drape, fenestrated, 2 tabs, paper, 18" x 26"
2	Towel, 13.5" x 18"
6	Gauze pad, 2" x 2"
3	Sponge stick applicator
1	Lidocaine 1%, 5 ml
1	Povidone-Iodine Topical Solution, 0.75 oz

### 5.3 Specimen Collection Kit Contents – LBD Emory

BL/Annual Collection Kit	
Supply	Amount
Siliconized cryogenic vial, 2ml	15
Serum (glass) tube, 10ml	2
EDTA (glass) tube, 10ml	2
EDTA (plastic) tube, 3ml	1
PAXGene® tube, 2.5ml	2
Bubble-tube sleeve	7
Disposable pipet, 3ml	2
Cryobox, 25 cell	1
Biohazard bag w/ absorbent sheet	2
Fragile label	1
UN3373 label	1
Dry ice label	1
Airway bill envelope	1
Frozen shipper	1
Label set (kit & specimen labels)	1

CSF Collection Kit	
Supply	Amount
Siliconized cryogenic vial, 2ml	11
Individually-wrapped conical tube, 15ml	2
Individually-wrapped conical tube, 50ml	2
Medication transfer filter straw	1
LP tray (22g or 24g available)	1

#### 5.4 Site Required Equipment

The following materials and equipment are necessary for the processing of specimens at the collection site and are to be **supplied by the local site**:

- Personal Protective Equipment: lab coat, nitrile/latex gloves, safety glasses
- Tourniquets
- Alcohol Prep Pads
- Gauze Pads
- Bandages
- Butterfly needles and hubs
- Microcentrifuge tube rack
- Test tube rack
- Sharps bin and lid
- Wet ice bucket (for CSF only)
- Wet ice (for CSF only)

In order to process samples consistently across all projects and ensure the highest quality samples possible, project sites must have access to the following equipment:

- Centrifuge capable of  $\geq 1500$  rcf (1500 x g) with refrigeration to 4°C
- -80°C Freezer

In order to ship specimens, you must provide:

- Dry ice (minimum 10 pounds per shipment)

## 6.0 SPECIMEN LABELS

Labels must be affixed on all collection and aliquot tubes to ensure unique specimen identity. BioSEND provides labels for all samples being collected and returned to BioSEND. The site is responsible for providing labels for biospecimens that will be retained at the site. **If labels are provided but the sample is not collected, please discard the unused labels.**

### 6.1 Types of Labels

Each kit contains all labels required for the return of biospecimens to BioSEND.



The **Case Labels** do not indicate a specimen type, but are affixed on BioSEND forms and on specific packing materials. See Appendices I-L for further instructions.

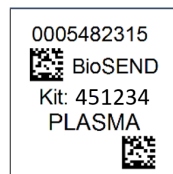

The **Collection and Aliquot Tube Labels** are placed on all sample collection and aliquot tubes. See [Appendices A-G](#) for further instructions.

## 6.2 Affixing Labels

In order to ensure the label adheres properly and remains on the tube, follow these instructions:

- Place specimen labels on **ALL** collection tubes and cryovials **BEFORE** sample collection, sample processing, or freezing. This will help to ensure the label properly adheres to the tube before exposure to moisture or different temperatures.
- The blood collection tube labels contain a 2D barcode on the left hand side of the label. When turned horizontally, the barcode should be closer to the top (cap end) of the tube.
- Place label **horizontally** on the tube (wrapped around sideways if the tube is upright); see below.

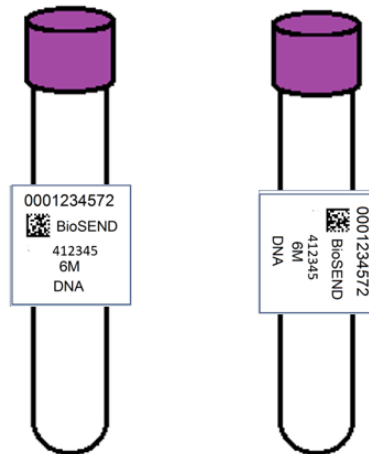

- Take a moment to ensure the label is **completely affixed** to each tube. It may be helpful to roll the tube between your fingers after applying the label.

## 7.0 SPECIMEN COLLECTION AND PROCESSING PROCEDURES

Consistency in sample collection and processing is essential for biomarker studies. All samples are drawn in the same order and then processed in a uniform fashion. **Please read the instructions before collecting any specimens. Have all your supplies and equipment out and prepared prior to drawing blood.**

### 7.1 Order of Specimen Collection

Blood collection should be performed in the following order:

1. Serum (red top) blood collection for serum (if applicable)
2. PAXgene® tube for RNA
3. EDTA (lavender top) blood collection for plasma and buffy coat
4. EDTA (purple top) blood collection for banking

### 7.2 Blood Collection Protocols

1. Serum (red top) blood collection for serum (**Appendix F**)
2. PAXgene® tube for RNA (**Appendix A**)
3. EDTA (lavender top) blood collection for plasma and buffy coat (**Appendix B and C**)
4. EDTA (purple top) blood collection for banking (**Appendix D**)

### 7.3 Lumbar Puncture Protocol

1. Cerebrospinal Fluid Collection (**Appendix G**)



#### 7.4 Filling Aliquot Tubes (Plasma, Serum, Buffy Coat, and CSF)

In order to ensure that BioSEND receives a sufficient amount of sample for processing and storage, and to avoid cracking of the tubes prior to shipment, each aliquot tube should be filled to the assigned volume (refer to detailed processing instructions for average yield per sample). Over-filled tubes may burst once placed in the freezer, resulting in a loss of that sample. Each site is supplied with sufficient collection tubes to provide the specimen volume described in the Protocol Schedules for Biospecimen Submission ([see Section 4](#)). Specimens collected in addition to those described in Section 4 are collected at the site's discretion and are not returned to BioSEND.

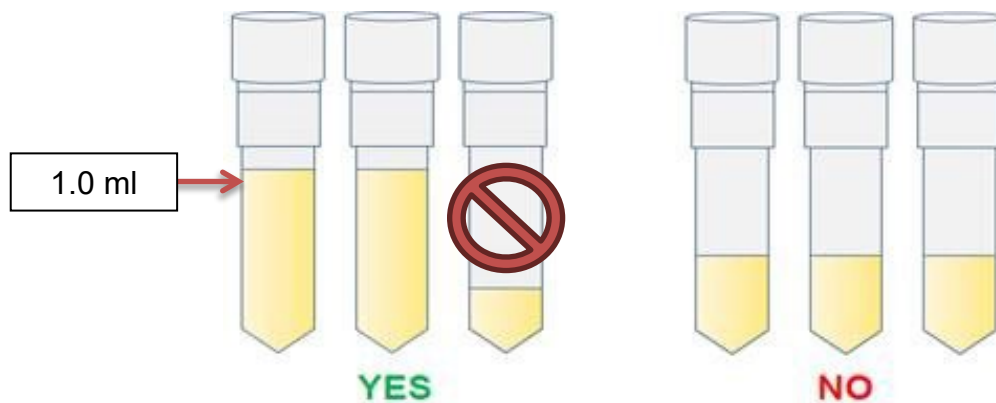

## 8.0 Packaging and Shipping Instructions

**ALL** study personnel responsible for shipping should be certified in biospecimen shipping. If not available at your institution, training and certification is available through the CITI training site (Course titled “Shipping and Transport of Regulated Biological Materials” at <https://www.citiprogram.org/>).

### 8.1 Sample Collection and Processing Form

The Specimen Collection and Processing Form should be completed for all samples submitted to BioSEND. Please see Appendix I for further instructions.

### 8.2 Shipping Instructions

All samples are shipped frozen on dry ice. Please reference Appendix K for frozen shipping instructions and Appendix Q for generating airbills and scheduling pick-ups.

- Frozen PAXgene® Tubes
- Frozen whole blood (3ml EDTA tube)
- Frozen 1 ml aliquots of plasma
- Frozen 1 ml aliquots of serum
- Frozen 1 ml aliquots of CSF
- Frozen Buffy Coat

### 8.3 Shipping Address

All samples are shipped to the BioSEND laboratory:

BioSEND  
Indiana University School of Medicine  
351 W. 10<sup>th</sup> Street. TK-217  
Indianapolis, IN 46202-5188

## 9.0 Data Queries and Reconciliation

Appendix I must be completed the day that samples are collected to capture information related to sample collection and processing. This form includes information that will be used to reconcile sample collection and receipt, as well as information essential to future analyses.

The NINDS DMR data collection team will be collaborating with BioSEND to reconcile information captured in the database compared to samples received and logged at BioSEND. Information that appears incorrect in the NINDS DMR database will be queried through the standard system. Additional discrepancies that may be unrelated to data entry will be resolved with the Principal Investigator in a separate follow up communication. If applicable, a non-conformance report will be provided to sites.

Data discrepancies with samples shipped and received at BioSEND may result from:

- Missing samples
- Incorrect samples collected and shipped
- Damaged or incorrectly prepared samples
- Unlabeled or mislabeled samples
- Discrepant information documented on the BioSEND Sample Form compared to information entered into the NINDS DMR database.
- Samples frozen and stored longer than three months at the site

**10.0 APPENDICES**

- Appendix A: Whole Blood Collection for Isolation of RNA
- Appendix B: Whole Blood Collection for Isolation of Plasma
- Appendix C: Whole Blood Collection for Isolation of Buffy Coat
- Appendix D: Whole Blood Collection for Banking
- Appendix F: Whole Blood Collection for Isolation of Serum
- Appendix G: Cerebrospinal Fluid Collection
- Appendix I: Sample Collection and Processing Form
- Appendix K: Frozen Shipping Instructions
- Appendix O: Low Fat Diet Menu Suggestions
- Appendix Q: UPS ShipExec™ Thin Client Instructions

## Appendix A – Whole Blood Collection for Isolation of RNA

Whole Blood Collection for Isolation of RNA: 2.5 ml PAXgene® tubes are provided by BioSEND for the collection of blood for RNA isolation.



See training video for blood collection for RNA: (<http://www.preanalytix.com/videos/rna-tube-collection-video/>)

1. **CRITICAL STEP:** Store PAXgene® tube(s) at room temperature 64°F - 77°F (18°C to 25°C) before use.
2. Place pre-printed “RNA” label on the PAXgene® tube(s) prior to blood draw.
3. Using a blood collection set and a holder, collect blood into the PAXgene® tube(s) using your institution's recommended procedure for standard venipuncture technique.



The following techniques shall be used to prevent possible backflow:

- a. Place donor's arm in a downward position.
  - b. Hold tube in a vertical position, below the donor's arm during blood collection.
  - c. Release tourniquet as soon as blood starts to flow into tube.
  - d. Make sure tube additives do not touch stopper or end of the needle during venipuncture.
4. Allow at least 10 seconds for a complete blood draw to take place in each tube. **Ensure that the blood has stopped flowing into the tube before removing the tube from the holder.** The PAXgene® tube with its vacuum is designed to draw 2.5 ml of blood into the tube.
  5. Immediately after blood collection, gently invert/mix (180 degree turns) the PAXgene® tube(s) 8 – 10 times. **Do not shake the tube!**
  6. Place the PAXgene® tube(s) upright in a **WIRE** or **PLASTIC** rack. Do **NOT** use a Styrofoam rack. This will cause the PAXgene® tube(s) to crack when frozen. **Allow the filled PAXgene® tube(s) to incubate upright at room temperature for 24 hours.**
  7. Complete the Sample Collection and Processing form (Appendix I).

8. After samples have incubated at room temperature for 24 hours, transfer the WIRE or PLASTIC rack with the PAXgene® tubes to **-80°C freezer**. Store all samples at **-80°C until shipped** to BioSEND on dry ice.
9. Ship the PAXgene® tubes to BioSEND according to **Appendix K - Frozen Shipping Instructions**.

## RNA Collection and Preparation – 2.5 ml PAXgene® Tube

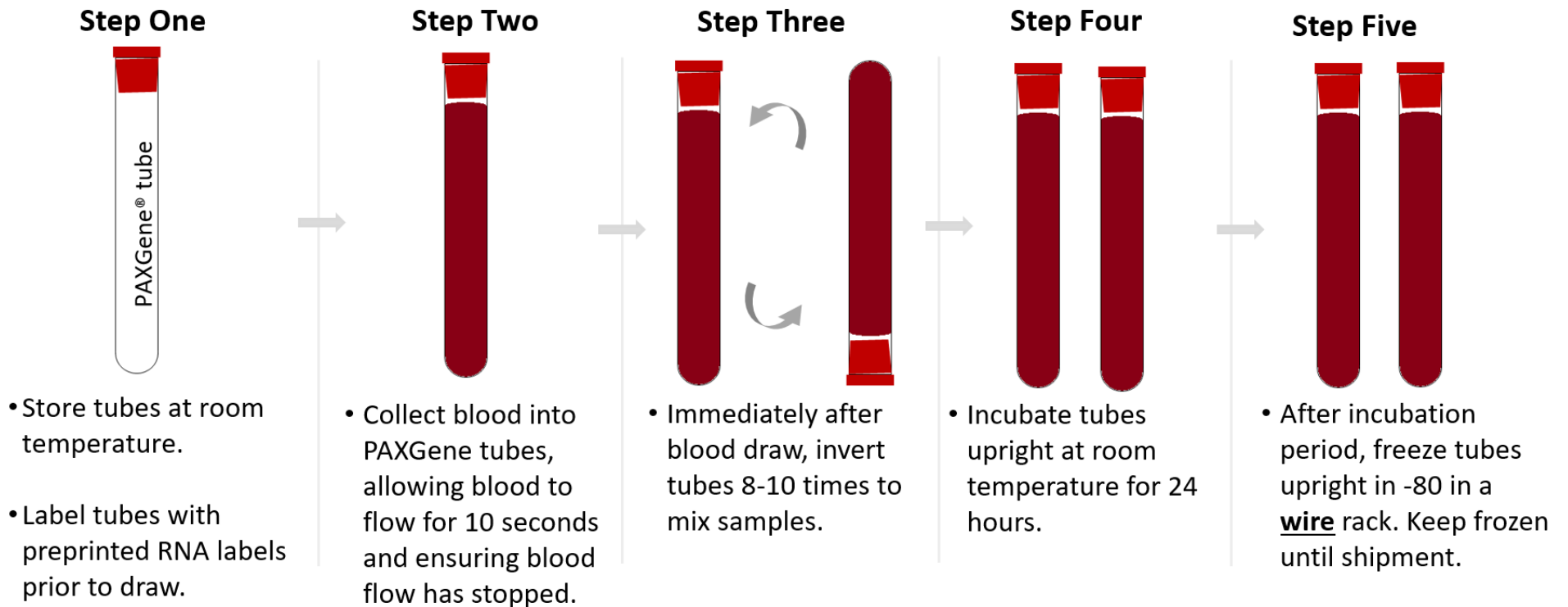



## Appendix B – Whole Blood Collection for Isolation of Plasma

Whole Blood Collection for Isolation of Plasma: 10 ml Purple-Top EDTA (glass) tube(s) and cryovials are provided by BioSEND for the collection of plasma.



1. **CRITICAL STEP:** Store empty Purple-Top EDTA tubes at room temperature 64°F – 77°F (18°C to 25°C) prior to use.
2. Place pre-printed collection and aliquot “**PLASMA**” label on 10 ml purple-top EDTA tube(s) and on six of the 2 ml cryovial tubes. The six labeled cryovials will be shipped to BioSEND. Any remaining cryovials can be retained by the site and labeled per site standards. Labels for aliquots kept by the site are not provided by BioSEND.
3. Please ensure that aliquots for BioSEND are kept in numerical order (by specimen barcode) throughout the aliquoting and shipping process.



4. Pre-chill the labeled cryovials on wet ice for at least 5 minutes.
5. Set centrifuge to 4°C to pre-chill before use. Time needed to pre-chill the centrifuge to 4°C will depend on your centrifuge model.
6. Using a blood collection set and a holder, collect blood into the **purple top 10 ml EDTA (glass) tube(s)** using your institution's recommended procedure for standard venipuncture technique.

**The following techniques shall be used to prevent possible backflow:**

- a. Place donor's arm in a downward position.
- b. Hold tube in a vertical position, below the donor's arm during blood collection.
- c. Release tourniquet as soon as blood starts to flow into the tube.
- d. Make sure tube additives do not touch stopper or end of the needle during venipuncture.

7. Allow at least 10 seconds for a complete blood draw to take place in each tube. **Ensure that the blood has stopped flowing into the tube before removing the tube from the holder.** The tube vacuum is designed to draw 10 ml of blood into the tube.
8. **CRITICAL STEP:** Immediately after blood collection, gently invert/mix (180 degree turns) the Lavender-Top EDTA tube(s) 8 – 10 times. Do not shake the tubes!
9. Within 30 minutes of blood collection, centrifuge balanced tubes for 15 minutes at 1500 RCF (x g) at 4°C. **It is critical that the tubes be centrifuged at the appropriate speed and temperature to ensure proper plasma separation (see worksheet in Appendix H to calculate RPM in your particular rotor).**
10. Remove the plasma by tilting the tube and placing the pipette tip along the lower side of the wall. **Use caution not to touch the buffy coat or packed red blood cells at the bottom of the tube so that the plasma is not contaminated** (see below). Using a disposable tipped micropipette, transfer plasma into the pre-labeled cryovials. Aliquot 1.0 ml per cryovial. Send 6 1.0 ml aliquots to BioSEND. If you cannot obtain the requested number of aliquots, please note “low volume draw” on the Sample Collection and Processing form (Appendix I) under “Notification of Problems”. Each 10 ml EDTA tube should yield, on average, 4 ml of plasma.

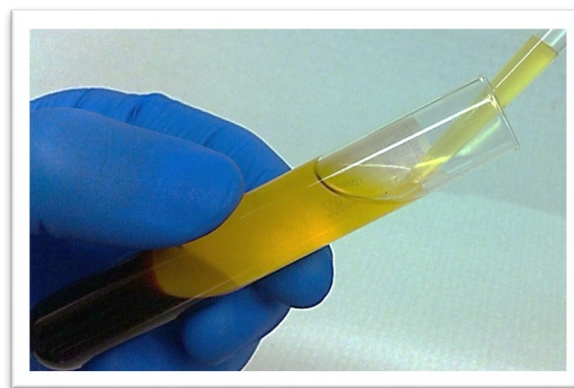
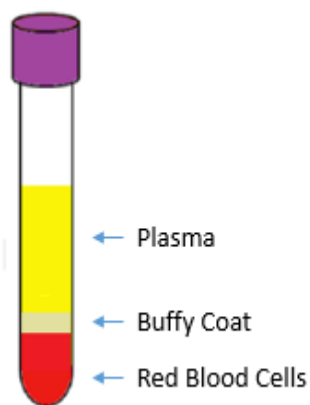

11. Complete the **Sample Collection and Processing form (Appendix I)**.
12. Place the labeled cryovials in the 25 slot cryobox. Place the cryobox UPRIGHT on dry ice. Transfer to **-80°C freezer as soon as possible, within 2 hours of blood draw**. Store all samples at **-80°C until shipped** to BioSEND on dry ice.
13. Ship the frozen plasma aliquots to BioSEND according to **Appendix K – Frozen Shipping Instructions**.

## Plasma Preparation –10 ml EDTA (Purple Top) Tube

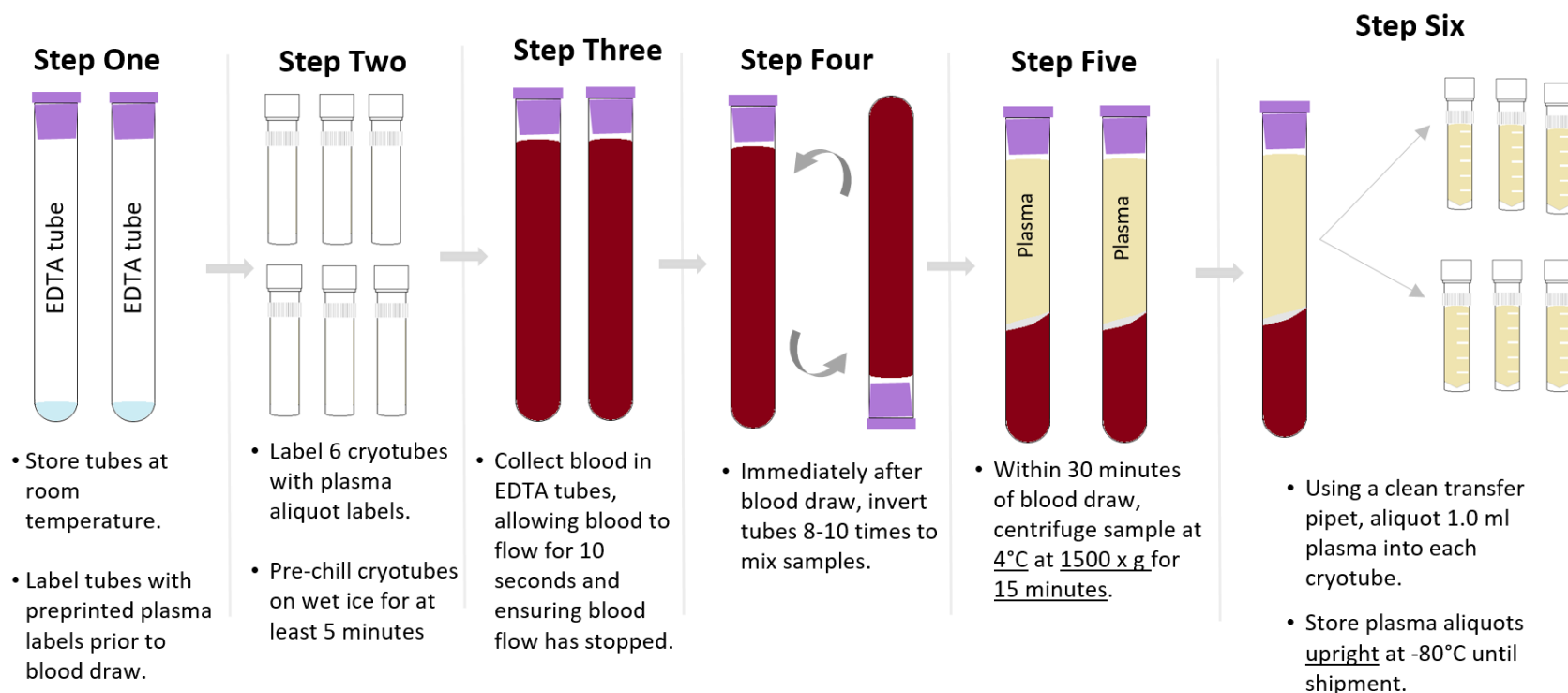

## Appendix C –Whole Blood Collection for Isolation of Buffy Coat

Whole Blood Collection for Isolation of Buffy Coat: 10 ml Lavender-Top EDTA tube(s) and cryovials are provided by BioSEND for the collection of the buffy coat.

1. Store Lavender-Top EDTA tubes at room temperature 64<sup>0</sup>F - 77<sup>0</sup>F (18°C to 25°C) before use.
2. Place pre-printed “**Buffy Coat**” labels onto two cryovials with clear cap.
3. After plasma has been removed from the EDTA lavender-top tube (see Appendix B), aliquot buffy coat layer (see figure below) into labeled cryovial with clear cap using a disposable graduated micropipette. All of the buffy coat from a single 10 ml lavender-top EDTA tube will be placed into one cryovial. The buffy coat aliquot is expected to have a reddish color from the red blood cells.

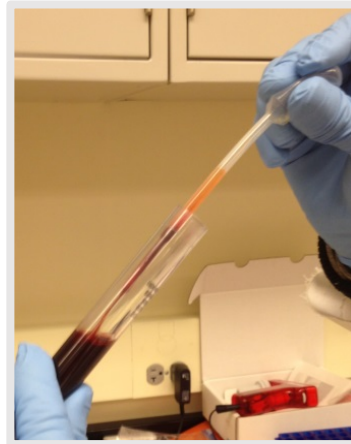
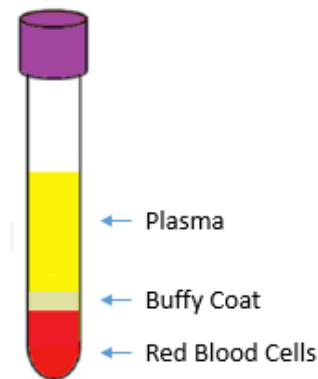

4. Complete the **Sample Collection and Processing form (Appendix I)**.
5. Place the labeled cryovial in the 25-slot cryovial box with the plasma cryovials and place on dry ice. Transfer to a **-80°C Freezer when possible**. Store all samples UPRIGHT at **-80°C until shipped** to BioSEND on dry ice.
6. Ship the frozen buffy coat aliquot to BioSEND according to **Appendix K – Frozen Shipping Instructions**.

## Buffy Coat Preparation –10 ml EDTA (Purple Top) Tube

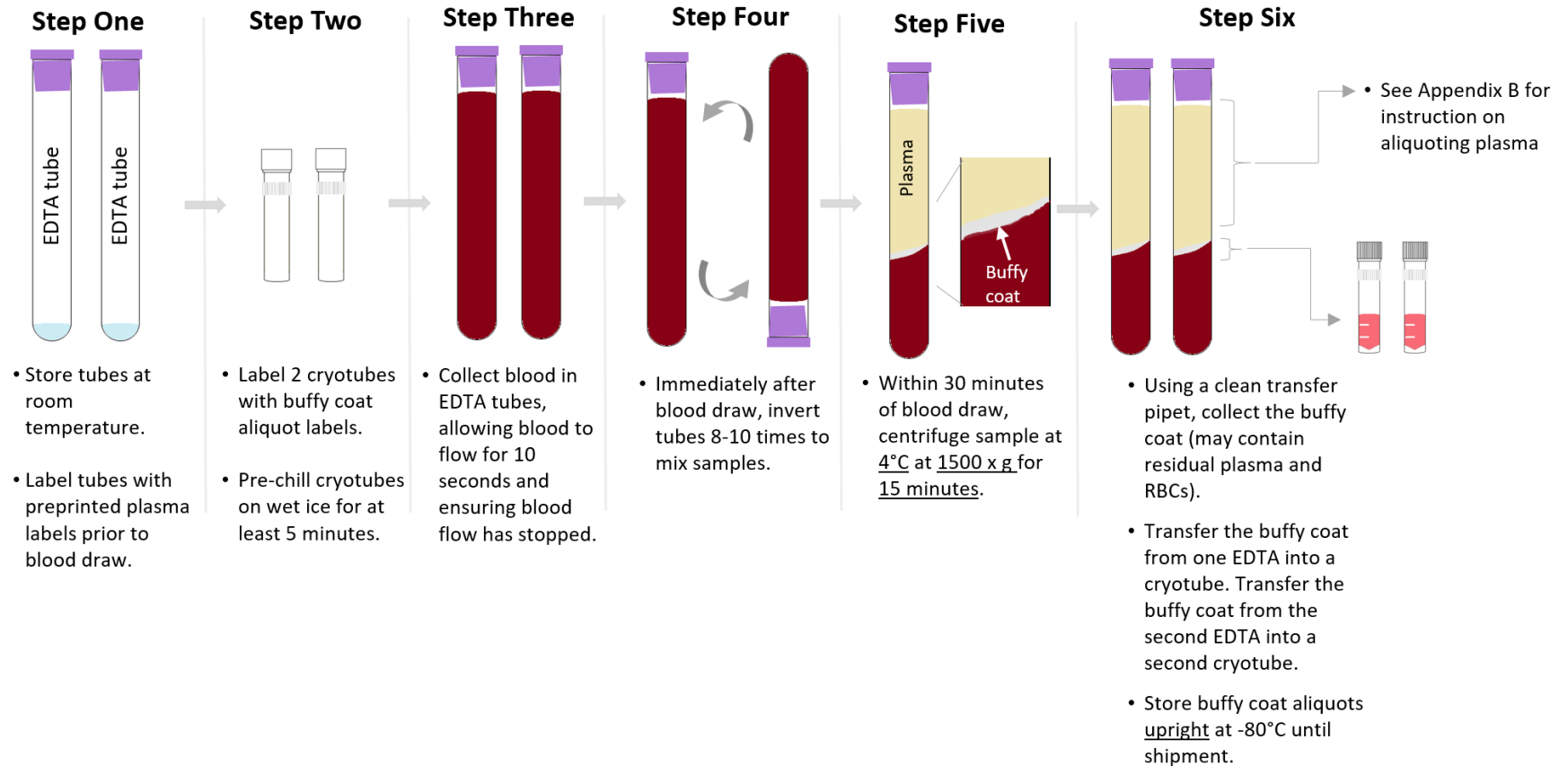

## Appendix D – Whole Blood Collection (No Processing)

One 3ml Purple-Top EDTA Tube is provided by BioSEND for Whole Blood collection (to be shipped to BioSEND FROZEN; no processing required).

1. Store empty tubes and collection supplies at room temperature, 64°F - 77°F (18°C to 25°C) before use.
2. Place pre-printed specimen label (WBLD) on the **one 3ml purple top EDTA tube** prior to blood draw.
3. Using a blood collection set and a holder, collect whole blood into the tubes using your institution's recommended procedure for standard venipuncture technique.

*The following techniques shall be used to prevent possible backflow:*

- a. Place donor's arm in a downward position.
  - b. Hold tube in a vertical position, below the donor's arm during blood collection.
  - c. Release tourniquet as soon as blood starts to flow into tube.
  - d. Make sure tube additives do not touch stopper or end of the needle during venipuncture.
4. **Immediately after blood collection, gently invert/mix (180 degree turns) the EDTA tube 8-10 times. Do not shake the tube!**
  5. Complete the Sample Collection and Processing form (Appendix I).
  6. Place the Purple-Top EDTA in a **WIRE** or **PLASTIC** rack. Do **NOT** use a Styrofoam rack. This will cause the Purple-Top EDTA tube to crack when frozen. Place the Purple-Top EDTA tube immediately to a **-80°C Freezer**.
  7. Ship the whole blood tube to BioSEND according to **Appendix K - Frozen Shipping Instructions**.

## WBLD Preparation – 1 x 3 ml K2 EDTA (Purple Top) Tube

### Step One



- Store tube at room temperature.
- Label tube with preprinted WBLD label prior to blood draw.

### Step Two



- Collect blood into 3ml EDTA tube, allowing blood to flow for 10 seconds and ensuring blood flow has stopped.

### Step Three

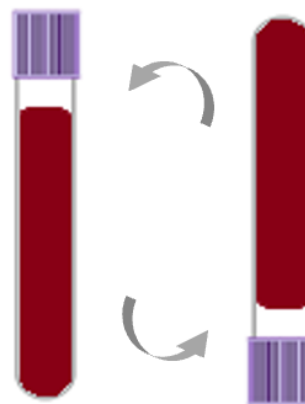

- Immediately after blood draw, invert tube 8-10 times to mix sample.

### Step Four



- Transfer to -80°C. Store upright and keep frozen until shipment to BioSEND.



## Appendix F – Whole Blood Collection for Isolation of Serum

Whole Blood Collection for Isolation of Serum: 10 ml red-top serum (glass) tubes and red-capped 2ml cryovial are provided by BioSEND for the collection of serum.

1. Store empty serum determination (red-top) tubes at room temperature 64°F – 77°F (18°C to 25°C) prior to use.
2. Place pre-printed specimen labels noted as “**SERUM**” on the serum determination red-top tubes and on six of the 2 ml red-capped cryovials prior to blood draw. These six red-capped cryovials will be shipped to BioSEND.
3. Pre-chill labeled red-capped cryovials on wet ice for at least 5 minutes or longer.
4. Set centrifuge to 4°C to pre-chill before use. Time needed to pre-chill the centrifuge to 4°C will depend on your centrifuge model.
5. Using a blood collection set and a holder, collect blood into the **10 ml red-top serum (glass) tubes** using your institution’s recommended procedure for standard venipuncture technique.

### **The following techniques shall be used to prevent possible backflow:**

- a. Place donor’s arm in a downward position
  - b. Hold tube in a vertical position, below the donor’s arm during blood collection
  - c. Release tourniquet as soon as blood starts to flow into tube.
  - d. Make sure tube additives do not touch stopper or end of the needle during venipuncture.
6. Allow at least 10 seconds for a complete blood draw to take place in each tube. Ensure that the blood has stopped flowing into the tube before removing the tube from the holder. The tube with its vacuum is designed to draw 10 ml of blood into the tube.
  7. Immediately after blood collection, gently invert/mix (180 degree turns) the serum determination tube 8-10 times. **Do not shake the tubes!**
  8. **Allow blood to clot at room temperature for at least 30 minutes.**
  9. Within 30 to 60 minutes from blood collection, centrifuge balanced tubes for 15 minutes at 1500 RCF (x g) at 4°C. **It is critical that the tubes be centrifuged at the appropriate speed and temperature to ensure proper serum separation.**

10. Remove the serum by tilting the tube and placing the pipette tip along the lower side of the tube wall. **Use caution to pipet only the serum layer and not the red blood cell layer.** Using a disposable tipped micropipette, transfer serum into the pre-labeled sarstedt tubes. Aliquot 1.5 ml per red-capped cryovials. Send 6 x 1.5 ml aliquots to BioSEND. Each 10 ml Serum tube should yield, on average, 4-5 ml of serum.
11. Complete the Sample Collection and Processing form (Appendix I).
12. Place the labeled sarstedt tubes in the 25 slot cryovial box. Place the cryobox UPRIGHT on dry ice. Transfer to **-80°C Freezer as soon as possible**. Store all samples UPRIGHT at **-80°C until shipped** to BioSEND on dry ice.
13. Ship the frozen serum aliquots to BioSEND according to **Appendix K – Frozen Shipping Instructions**.

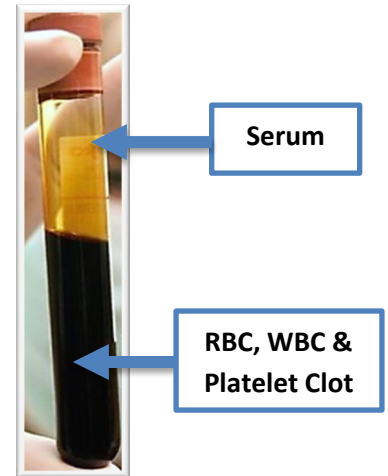

## Appendix G — Cerebrospinal Fluid Collection

**Important Note**

CSF should be collected in the morning between 8am – 10am, preferably fasted.

### 1. Lumbar Puncture Supplies

The lumbar puncture tray contains the following items, which will be used to perform the lumbar puncture. Check the dates of expiration: these reflect the expiration date of the lidocaine and sterile seal. Supplies for shipment of CSF are sent with the blood collection kit.

#### a. Lumbar Puncture Tray Components

Quantity	Lumbar Puncture Tray Kit Components
1	Sprotte® needle, 24G x 90mm*
1	Introducer needle, 1 mm x 30 mm
1	Hypodermic needle, 22G x 1.5"
1	Plastic syringe, (3 ml, luer lock) with 25G x 5/8" needle attached
4	Polypropylene syringe (6 ml, luer lock)
1	Needle stick pad
1	Adhesive bandage
1	Drape, fenestrated, 2 tabs, paper, 18" x 26"
2	Towel, 13.5" x 18"
6	Gauze pad, 2" x 2"
3	Sponge stick applicator
1	Lidocaine 1%, 5 ml
1	Povidone-Iodine Topical Solution, 0.75 oz

\*Trays with 22G x 90mm Sprotte® needle and introducer available upon request.

Sterile, individually packaged 50 ml conical tubes are provided for sites who are completing the Lumbar Puncture through the use of the gravitational method. Please ensure that all supplies necessary for a participant draw are available at your site at least two weeks prior to the appointment.

## 2. Setting Up the LP

- a. On an overbed table, remove the contents of the LP kit from the outer plastic packaging, leaving the contents wrapped in their sterile drape. Leave everything wrapped until the person performing the LP is seated and begins examining the subject.
- b. Feel the outside of the LP kit (still wrapped) to determine which end contains the spongy swabs. Turn this end toward the person performing the LP and begin unwrapping the kit.
- c. Touch only the outside of the paper wrapper. When you grab an edge to unfold it, touch only the folded under portions of the outside of the wrapper. Also, don't let the outside of the wrapper touch any part of the inside. If you touch any part of the paper wrapper, or if any non-sterile object outside of the wrapper touches any part of the inside of the wrapper, discard the kit and start over. If you are in doubt as to whether something touched the inside of the paper wrapper, throw the kit away and start over.

## 3. Maintaining the sterile field

- a. Keep in mind that there are usually many staff in the room during an LP, and a big part of assisting with the LP is keeping the field sterile—keeping people away from it, and reminding them to be careful around it. If anyone touches the inside of the paper wrapper or any part of the contents of the kit, throw the kit away and start over. If you are in doubt as to whether someone touched the kit, throw it away and start over. Also, you are the monitor for whether the person performing the LP has broken sterility usually by touching something not sterile with a sterile gloved hand. Feel free to speak up and inform people if need be. Be assertive.

## 4. Tips for Clinicians Performing Lumbar Puncture: Optimizing patient comfort and minimizing the risk of adverse events.

- a. Talk the patient through the procedure so that there are no surprises.
- b. Use of a Sprotte® 24g or 22g atraumatic spinal needle and careful technique are optimal for reducing post-LP headache risk. This Sprotte® 24g or 22g atraumatic spinal needle is included in the BioSEND LP Tray; additional needles may be ordered upon request. A pencil point spinal needle such as Whitacre® 24g, Spinocan® 22g, or other 24g may also be used.
- c. Use adequate local anesthesia. Use the 25g 1/2" needle and inject lidocaine to raise a skin wheal. Then, inject lidocaine using the pattern of a square— first the center, and then to all 4 corners. If the subject is thin, do not insert the deep infiltration needle

OR the spinal introducer all the way. Use only about 2/3 of their length (to prevent entering the subarachnoid space with anything other than the 24g pencil point spinal needle).

- d. Encourage fluid intake immediately after LP is helpful.
- e. Be sure to give post-LP care instructions verbally to the subject (see below).

## 5. Post-LP Care Instructions

- Advise the subject to refrain from exertion (e.g., exercise, housework, gardening, lifting, sexual activity, or any other strenuous activities) for 24 hours after the LP.
- Advise the subject to continue with increased fluid intake.

### a. Mild to Moderate headache after a lumbar puncture

- Mild to Moderate headache following lumbar puncture usually resolves within 3-4 days.
- Treatment of Mild to Moderate headache:
  - Limit physical activity as much as possible.
  - Oral fluids and caffeine are helpful. Drinking a soft drink (for example) is preferable to coffee, which has some diuretic activity.
  - Acetaminophen should be used for symptomatic relief. If a subject cannot tolerate acetaminophen, ibuprofen should be used. Avoid aspirin. If these do not relieve the headache, acetaminophen with codeine or an equivalent could be considered.

### b. Severe headache after a lumbar puncture

If the headache becomes severe, posturally sensitive (relieved by supine posture), or is accompanied by nausea, vomiting, tinnitus, and/or visual disturbances, the subject should contact the site study staff for further instruction per standard clinical care.

## 6. Detailed Lumbar Puncture Procedure

- a. Place the preprinted Collection and Aliquot “CSF” labels on the collection and ten 2 ml aliquot tubes. These 10 tubes will be shipped to BioSEND. Prepare the remaining 2 ml aliquot tubes and label per your site’s CSF protocols. The remaining tubes will be retained by the site.
- b. **CSF cryotubes should remain at room temperature; do not pre-chill these tubes.**
- c. Perform lumbar puncture using the atraumatic technique.
- d. Collect CSF into syringes or sterile conical tube (if a noticeably bloody tap, discard the first 1-2 mls). After the LP has begun and fluid is being collected, aliquot the first 1-2 mls of CSF from the first syringe into one of the additional cryovials provided by BioSEND, and send it to the local lab for routine diagnostic tests, if applicable.
- e. Collect additional CSF per your site’s protocol and transfer to 50 ml conical polypropylene tube at room temperature. Firmly cap and mix gently by inverting 3-4 times. Record the time of draw (once collection is complete) on the DMR CSF Processing Form. Also ensure that the time of last meal consumed by participant has been documented.
- f. Within 15 minutes of collection, transfer the CSF from the 50 ml conical tube to two 15 ml conical tubes ensuring that there is equal volume in each. Spin the CSF samples down at 2000 x g for 10 minutes at **room temperature**, 64°F – 77°F (18°C to 25°C).
- g. After centrifugation, pipette the supernatant from both 15 ml conical tubes and transfer to a new 50 ml conical tube. Ensure that debris at the bottom of the 15 ml conical tubes are not disturbed. Firmly cap the 50 ml conical tube and mix gently by inverting 3-4 times.
- h. Pipette (micropipette preferred) 1.0 ml of supernatant directly into each of the pre-labeled aliquot tubes to be sent to BioSEND.
  - Remaining CSF should be aliquoted according to your site’s protocols. If there is no local repository, BioSEND will accept all aliquots.
- i. Place the labeled cryovials in the 25-slot cryobox and place UPRIGHT on dry ice. Transfer to **-80°C Freezer**. Store all samples at **-80°C until shipped** to BioSEND on dry ice.
- j. Ship the CSF aliquots to BioSEND according to **Appendix K – Frozen Shipping Instructions**.

## CSF Collection and Preparation

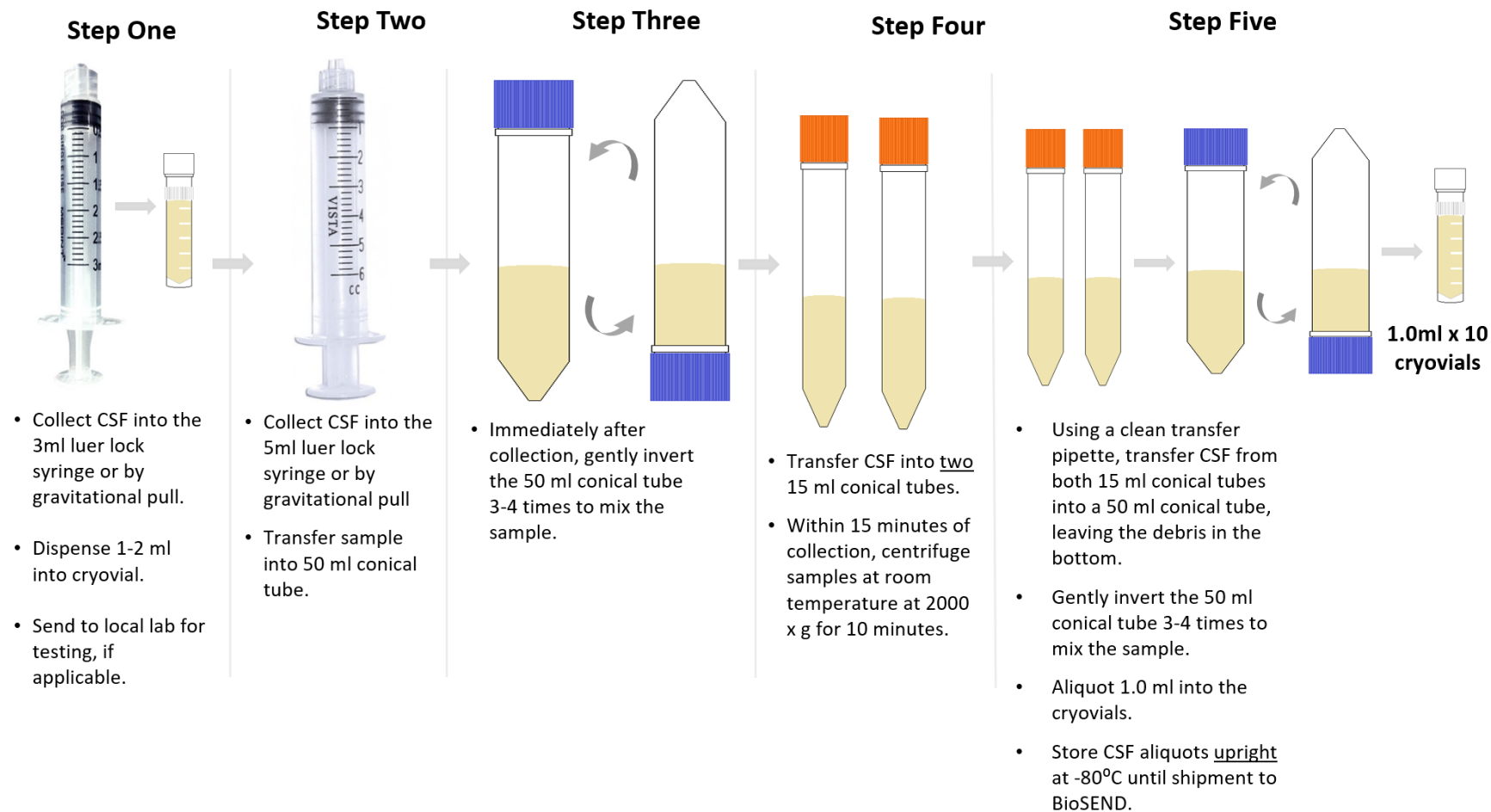

## Appendix I – Sample Collection and Processing Form

A Sample Collection and Processing Form must be completed for each subject-visit submitted to BioSEND. This form includes a Frozen Shipping Manifest that should be completed in advance of shipping to BioSEND also be physically included in the shipper. The form can be completed via REDCap by following the bellow link:

- **Link to Sample Collection and Processing Form:**  
<http://kits.iu.edu/biosend/EmoryLBDSampleForm>

Please note that there is a Save & Return option at the bottom of the survey. This may be used if, for example, you are ready to complete the Collection and Processing portion of the form, but not yet ready to complete the Frozen Shipping Manifest.

It is preferred that you complete the form online via the REDCap link above. However, a copy of the printed form is available on the following pages, should you need a back-up option. Please note that if you do not complete the form online, you will need to email a copy of the form directly to [biosend@iu.edu](mailto:biosend@iu.edu) prior to shipment.



# LBD Emory Specimen Collection And Processing Form

Please complete the Specimen Collection and Processing Form, below.

---

LBD Emory Study (PDBP Study ID 238)

---

Study Site

Emory University

---

Email address of staff member completing this form

\_\_\_\_\_

Note: A copy of the completed sample form and the shipping manifest will be sent to this address.

---

GUID

\_\_\_\_\_

---

Sex (used for DNA quality control)

- Male
- Female
- Other

---

Visit

- BL
- 12M
- 24M
- 36M
- 48M

---

ST Number

\_\_\_\_\_ (eg, ST-1001234)

**Blood Collection and Processing**

Date of venipuncture blood collection

---

Time of venipuncture blood collection

---

  
(Use 24 Hour clock)

SERUM (red-top tubes, 10 mL)

Was blood collected and processed for SERUM?

- Yes  
 No

Time of SERUM tube centrifugation

---

  
(Use 24 Hour clock)

Duration of SERUM tube centrifugation

---

  
(minutes)

Rate of SERUM tube centrifugation

---

  
(x g)

Temperature of SERUM tube centrifugation

---

  
(degrees Celsius)

Total volume of SERUM collected

---

  
(mL)

Number of SERUM aliquots created

---

  
(Each aliquot should be 1 mL)

Time SERUM aliquots were placed in freezer

---

  
(Use 24 Hour clock.)

SERUM storage temperature

---

  
(degrees Celsius)

SERUM notes

---

RNA (PAXGene™ tubes, 2.5 mL)

Was blood collected and processed for RNA?

- Yes  
 No

Number of PAXGene™ tubes collected for RNA

---

Date RNA was frozen \_\_\_\_\_

Time RNA was placed in freezer \_\_\_\_\_

RNA storage temperature \_\_\_\_\_  
(degrees Celsius)

RNA notes \_\_\_\_\_

PLASMA and BUFFY COAT (Purple-top EDTA tubes, 10 mL)

Was blood collected and processed for PLASMA EDTA?  Yes  No

Time of PLASMA EDTA tube centrifugation \_\_\_\_\_  
(Use 24 Hour clock)

Duration of PLASMA EDTA tube centrifugation \_\_\_\_\_  
(minutes)

Rate of PLASMA EDTA tube centrifugation \_\_\_\_\_  
(x g)

Temperature of PLASMA EDTA tube centrifugation \_\_\_\_\_  
(degrees Celsius)

Total volume of PLASMA EDTA collected \_\_\_\_\_  
(mL)

Number of PLASMA EDTA aliquots created \_\_\_\_\_  
(Each aliquot should be 1 mL)

Number of BUFFY COAT aliquots created \_\_\_\_\_

Time PLASMA EDTA and BUFFY COAT were placed in freezer \_\_\_\_\_  
(Use 24 Hour clock.)

PLASMA EDTA and BUFFY COAT storage temperature \_\_\_\_\_  
(degrees Celsius)

---

PLASMA EDTA notes

---

---

WHOLE BLOOD (EDTA tube, 3 mL)

---

Was blood collected for WBLD?  Yes  
 No  
(WBLD not collected by Columbia, Harvard, or Michigan sites)

---

Time WBLD was placed in freezer

---

(Use 24 Hour clock)

---

WBLD storage temperature

---

(degrees Celsius)

---

---

WHOLE BLOOD notes

---

**CSF Processing**

Was CSF collected?  Yes  
 No

Date of CSF collection \_\_\_\_\_

Time of CSF collection \_\_\_\_\_  
(Use 24 Hour clock)

Time of CSF centrifugation \_\_\_\_\_  
(Use 24 Hour clock)

Duration of CSF centrifugation \_\_\_\_\_  
(minutes)

Rate of CSF centrifugation \_\_\_\_\_  
(x g)

Was CSF centrifuged at room temperature?  Yes  
 No  
(degrees Celsius)

Temperature of CSF centrifugation \_\_\_\_\_  
(degrees Celsius)

Total volume of CSF collected \_\_\_\_\_  
(mL)

Number of CSF aliquots created \_\_\_\_\_  
(Each aliquot should be 1 mL)

Time CSF aliquots were placed in freezer \_\_\_\_\_  
(Use 24 Hour clock)

CSF storage temperature \_\_\_\_\_  
(degrees Celsius)

CSF notes \_\_\_\_\_

# LBD Emory Frozen Shipping Manifest

Please verify/update the information below. When you click the "Submit" button below, a PDF copy of the Frozen Shipping Manifest will be emailed to you for Subject [subj\_id].

Please print a copy of that document and include it in the shipping container.

Study Site:

Emory University

GUID:

\_\_\_\_\_

Visit:

- BL
- 12M
- 24M
- 36M
- 48M

ST Number:

\_\_\_\_\_

Date of blood collection:

\_\_\_\_\_

Date of CSF collection:

\_\_\_\_\_

## SERUM

Number of SERUM aliquots shipped:

\_\_\_\_\_

## RNA

Number of PAXGene™ tubes shipped:

\_\_\_\_\_

## PLASMA EDTA

Number of PLASMA EDTA aliquots shipped:

\_\_\_\_\_

Number of BUFFY COAT aliquots shipped:

\_\_\_\_\_

## WHOLE BLOOD EDTA

Number of WHOLE BLOOD tubes shipped:

\_\_\_\_\_

**CSF**

Number of CSF aliquots shipped: \_\_\_\_\_

**Shipping Information - Please complete.**

Frozen shipments should be sent Monday-Wednesday only. Please check for holiday closures prior to shipping. Contact us at biosend@iu.edu if you are unsure whether or not it is safe to ship.

Date of shipment: \_\_\_\_\_

Did/will you use the IU UPS interface to generate the shipping label?  Yes  No

Which shipping service did you use?  UPS  FedEx  World Courier  Other

What is the shipment tracking number? \_\_\_\_\_

## Appendix K – Frozen Shipping Instructions

### IMPORTANT!

Frozen samples must be shipped Monday – Wednesday only,  
using Next Day Air delivery

Please be aware of holidays and inclement weather and plan your shipments accordingly. Reach out to [biosend@iu.edu](mailto:biosend@iu.edu) if you have any questions

Specimens being shipped to BioSEND are Category B UN3373 specimens and as such must be triple packaged and compliant with IATA Packing Instructions. *See the latest eEdition of the IATA regulations for complete documentation.*

Triple packaging consists of a primary receptacle(s), a secondary packaging, and a rigid outer packaging. The primary receptacles must be packed in secondary packaging in such a way that, under normal conditions of transport, they cannot break, be punctured, or leak their contents into the secondary packaging. Secondary packaging must be secured in outer packaging with suitable cushioning material. Any leakage of the contents must not compromise the integrity of the cushioning material or of the outer packaging.

### IATA Packing and Labeling Guidelines

- The primary receptacle (cryovials or blood collection tubes) must be leak proof and must not contain more than 1 L total.
- The secondary packaging (plastic canister or biohazard bag) must be leak proof and if multiple blood tubes are placed in a single secondary packaging, they must be either individually wrapped or separated to prevent direct contact with adjacent blood tubes.
- Absorbent material must be placed between the primary receptacle (cryovials or blood collection tubes) and the secondary packaging. The absorbent material must be of sufficient quantity to absorb the entire contents of the specimens being shipped. Examples of absorbent material are paper towels, absorbent pads, cotton balls, or cellulose wadding.
- A shipping manifest listing the specimens being shipped must be included between the secondary and outer packaging.
- The outer shipping container must display the following labels:
  - ✓ Sender's name and address
  - ✓ Recipient's name and address
  - ✓ Responsible persons (shipper and recipient)
  - ✓ The words "Biological Substance, Category B"
  - ✓ UN3373
  - ✓ Class 9 label including UN 1845, and net weight of dry ice contained



**BioSEND Packaging and Shipment Instructions – Frozen Shipments**

1. Generate airway bill and schedule courier pick-up, as needed.
  - For instructions on generating airway bills and scheduling using the UPS ShipExec™ Thin Client system, see Appendix Q.
2. Record the tracking number onto the Sample Collection and Processing form (Appendix I).
3. Print a copy of the Shipping Manifest portion of the Appendix I.
4. Place all frozen labeled cryotubes in the cryobox. Only include specimens from one subject in each cryobox.
5. Place the cryobox in a clear plastic biohazard bag (do NOT remove the absorbent material found in the bag), and seal the biohazard bag according to the instructions on the bag. Affix a Case Label to the outside of the biohazard bag.



6. Place approximately 2-3 inches of dry ice in the bottom of the Styrofoam® shipping container.
7. If your protocol is collecting frozen whole blood, DNA, or RNA, place labeled tubes in bubble sleeves and seal.
8. Place the tubes in a clear plastic biohazard bag (do NOT remove the absorbent material found in the bag), and seal the biohazard bag according to the instructions on the bag. Affix a Case Label to the outside of the biohazard bag.
9. Place the biohazard bag containing the cryobox into the provided Styrofoam® shipping container on top of the dry ice. Please ensure that the cryobox is placed so that the cryovials are upright in the shipping container (as pictured).



10. Fully cover the cryobox with approximately 2 inches of dry ice. Do not include more than 2 subjects' worth of samples in a single shipper.
11. If including additional biohazard bags in package, include a layer of dry ice (approximately 2 inches) between each biohazard bag.
12. The inner Styrofoam® shipping container must contain approximately 10 lbs (or 4.5 kg) of dry ice. The dry ice should entirely fill the inner box to ensure the frozen state of the specimens.
13. Replace the lid on the Styrofoam® container. Place the completed Shipping Manifest in the package on top of the Styrofoam® lid for each patient specimen, and close and seal the outer cardboard shipping carton with packing tape.
14. Print a copy of your UPS® airway bill generated through the UPS ShipExec™ Thin Client system (see Appendix Q). Place airway bill into the provided airway bill envelope and affix envelope to package.
15. Complete the Class 9 UN 1845 Dry Ice Label (black and white diamond) with the following information:
  - Your name and return address
  - Net weight of dry ice in kg (this amount must match the amount recorded on the airway bill)
  - Consignee name and address:

BioSEND  
IU School of Medicine  
351 W. 10<sup>th</sup> Street  
TK-217  
Indianapolis, IN 46202

- Do not cover any part of this label with other stickers, including pre-printed address labels.

<b>IMPORTANT!</b>
Complete the required fields on your airway bill and Class 9 Dry Ice labels, or courier may reject or return your package.

16. Apply all provided warning labels (UN3373, Dry Ice Label and Fragile Label), taking care not to overlap labels with each other or with airway bill.
17. Hold packaged samples in -80°C freezer until time of courier pick-up/drop-off.
18. Specimens should be sent to the address below. Frozen shipments should be sent Monday through Wednesday only to avoid shipping delays on Thursday or Friday.

BioSEND  
IU School of Medicine  
351 W. 10<sup>th</sup> Street  
TK-217  
Indianapolis, IN 46202

19. **Complete the Shipping Manifest portion of Sample Collection and Processing Form. Submitting this form via REDCap will automatically notify BioSEND of shipment. If unable to use the REDCap version of the form, complete the PDF version in the MOP and notify BioSEND by email ([biosend@iu.edu](mailto:biosend@iu.edu)), with an attachment of the form Do not ship until you've contacted and notified BioSEND staff about the shipment in advance.**
20. Use courier tracking system to ensure the delivery occurs as scheduled and is received by BioSEND.

In addition to tracking and reconciliation of samples, the condition and amount of samples received are tracked by BioSEND for each sample type. Investigators and clinical coordinators for each project are responsible for ensuring that the requested amounts of each fluid are collected to the best of their ability and that samples are packed with sufficient amounts of dry ice to avoid thawing in the shipment process.

## Appendix O – Low Fat Diet Menu Suggestions

### Foods to avoid prior to blood collection:

**Avoid:** *All fats and nuts such as:*

- Butter
- Cream
- Bacon fat
- Lard
- All oils
- All margarine
- All nuts
- Peanut butter
- Coconut
- Whole seeds such as pumpkin and sunflower

**Avoid:** *All milk and dairy products such as:*

- All whole milk products
- All cheese
- All products containing cheese
- Sour cream
- All ice cream
- Milk chocolate

**Avoid:** *High fat prepared foods and foods naturally high in fat:*

All red meats or meats containing fat  
such as pork and:

- Fatty meats such as:
  - Luncheon meats
  - Organ meats
  - Bacon
- Fatty fish such as:
  - Salmon
  - Mackerel

- 
- Salad dressing and mayonnaise
  - Fried foods
  - Fried snacks such as:
    - Chips
    - Crackers
    - French Fries
  - Buttered, au gratin, creamed, or fried vegetables
  - Gravies and sauces
  - Baked goods and frosting

## Appendix Q - UPS ShipExec™ Thin Client Instructions

\*\*\* The shipment label in ShipExec should not be created until the day of shipment \*\*\*

- 1) Log in to the UPS ShipExec™ Thin Client website: <https://kits.iu.edu/UPS> or <https://kits.iu.edu/ups>.
  - a. To request an account, complete the following survey:  
<https://redcap.uits.iu.edu/surveys/?s=88TTWY3KAF>
- 2) Find the “Shipping” dropdown menu in the top left corner of the screen and click on “Shipping and Rating”.
- 3) Once the Indiana University page loads, look for the “Study Group” dropdown menu under “Shipment Information” on the right side of the screen. Choose your study from the dropdown menu.
- 4) After selecting your study, click on the magnifying glass icon on the left side of the screen under “Ship From”.
- 5) An address book and filters will populate the screen. On the right side of the screen, a list of all the site addresses within the study you selected should populate.
  - a. Filter the list down more by looking to the left side of the screen and searching for their address by filling in the “Company”, “Contact”, or “Address 1” fields. Click on the Search button when ready.
  - b. Once you have found your site address, click on the “Select” button to the left of the address.
- 6) Make sure your address populated in the fields under “Ship From” on the main page.
  - a. If you accidentally selected the wrong address, click on the “Reset” button on the bottom right of the screen. After the page reloads and clears the information, select your study again from the “Study Group” menu and click on the magnifying glass icon again to search for your correct address.
  - b. To change the address for your site and study group, please complete the following survey:  
<https://redcap.uits.iu.edu/surveys/?s=88TTWY3KAF>
- 7) Enter the total weight of your package in the “Weight” field on the right side of screen under the name of your study.
  - a. Leave the “Dry Ice Weight” field empty or enter “0” if shipping an ambient sample.
- 8) Enter the weight of the dry ice for frozen shipments in the “Dry Ice Weight” field.
  - a. The “Dry Ice Weight” field can *never* be higher than the “Weight” field.
  - b. **(Steps 9-10 can be skipped if you do not need to schedule a pickup)**
- 9) After entering the weights, click on the blue “Pickup Request” button.
- 10) When the Create Pickup Request box pops up, enter information into all the fields provided.
  - a. Enter the “Earliest Time Ready” and “Latest Time Ready” in 24-hour format.
    - i. Schedule pickup at a minimum 1 hour *before* the “Earliest Time Ready”
  - b. Choose a name and phone number that is the best contact if the UPS driver has question related to picking up your package
  - c. Entering the “Room Number” and “Floor” will help the UPS driver locate your package
    - i. The “Floor” field only allows numerical characters while the “Room Number” field is free text.
  - d. Click “Save” when done.
- 11) Once you are certain that all the correct information has been entered, click the “Ship” button in the bottom right corner of the screen.
- 12) If no red error messages pop up at the top of your screen after clicking on “Ship”, then you should have 2 downloaded PDF files: Shipment Receipt & UPS Package Label

- a. Shipment Receipt will list a “Pickup No.” that references your specific package if there is ever an issue with UPS picking up your package
- 13) Print out the UPS airway bill to any printer at your location.
    - a. Fold the UPS airway bill and slide it inside the plastic UPS sleeve.
    - b. Peel the back off the plastic UPS sleeve and stick the sleeve to your package, making sure it is laying as flat as possible along the surface of the package.
  - 14) Place your package in the spot designated in your pickup request, or wherever your daily UPS pickups occur.
  - 15) If you need to reprint your airway bill or void your shipment, click on “History” at the top of the main screen.
    - a. If your shipment does not automatically pop up, enter the date of shipment and then click “Search”.
    - b. To reprint your airway bill, click on the printer icon to the far left under “Action”
    - c. To void your shipment, click on the “X” icon to the far left under “Action”
      - i. If you created an airway bill that you no longer need, you must void the shipment to ensure your study will not be charged for the shipment.